

### Description

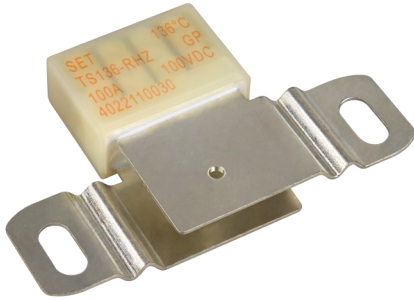

The Direct Current Thermal-Link Alloy Type (DC-ATCO) is defined as a non-resettable protective device functioning only once. It is widely used for over-temperature protection of electrical equipment and electric vehicles. The DC-ATCO primarily consists of Case, a low melting point Thermal Element, Flux Resin, Sealant and Electrode Lead. Normally, the Thermal Element is joined to the two lead wires. When the temperature reaches the fusing temperature of the Direct Current Thermal-Link (Alloy Type), the Thermal Element melts and quickly retracts to the two lead wire ends with the aid of the flux resin, disconnecting the circuit completely.

The SETsafe | SETfuse Direct Current Thermal-Link (Alloy Type) is classified into Axial and Radial shapes, with a Rated Functioning Temperature ranging from 102 °C to 136 °C, Rated Current: 80 A, 100 A, Rated Voltage: 100 VDC, 250 VAC, 125 VAC, and it holds UL, cUL Approvals. It is also RoHS and REACH compliant.

### Marking

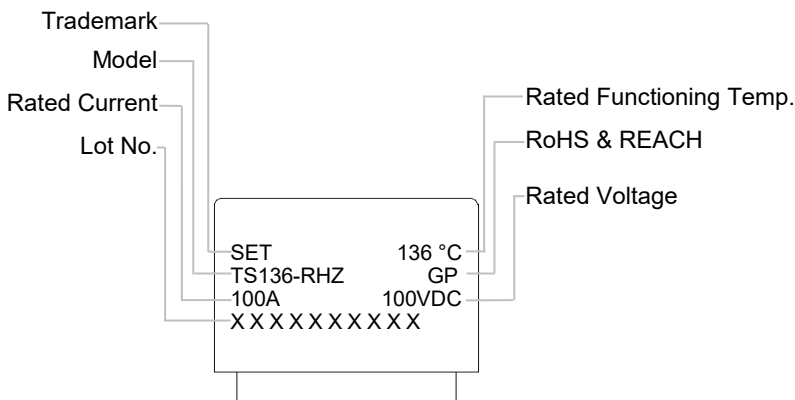

### Structure Diagram

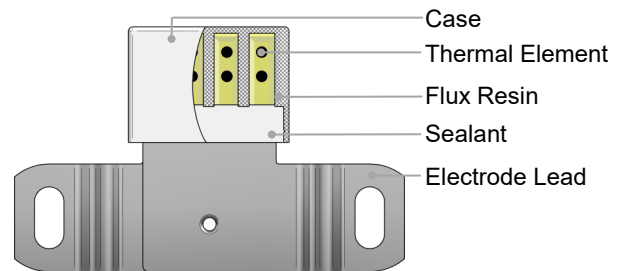

### Product Schematic

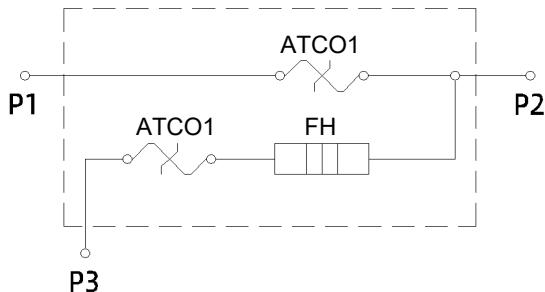

### Features

- High Accuracy of Functioning Temp.
- Non-Resettable
- RoHS & REACH Compliant

### Applications

- EV Battery Modules
- Automatic Electronics

### Customization

- Rated Functioning Temp.
- The Shape of Electrode Lead

### Agency Information

Agency Symbol	Standards	The File No. and certification No. obtained by SETsafe   SETfuse
	UL60691	E214712
	CAN-CSA-E60691	E214712

# DC-ATCO

Direct Current Thermal-Link (Alloy Type)

TS Series

## Part Number System

TS136 - R H Z

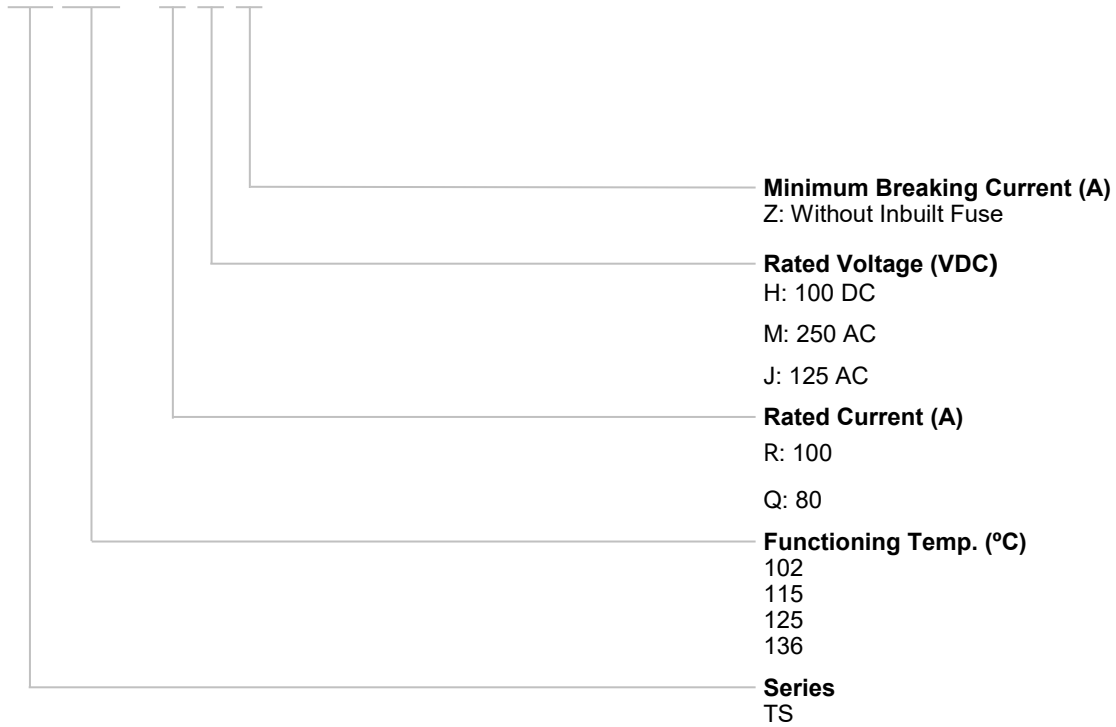

# DC-ATCO

Direct Current Thermal-Link (Alloy Type)

TS Series

## Dimensions (Unit: mm)

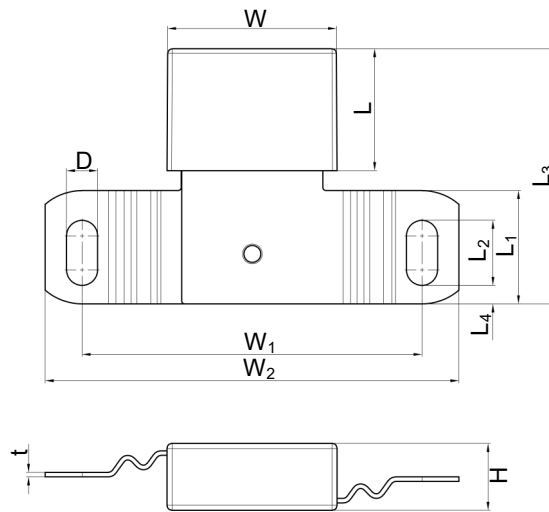

L	L <sub>1</sub>	L <sub>2</sub>	L <sub>3</sub>	L <sub>4</sub>	W	W <sub>1</sub>	W <sub>2</sub>	D	H	t
21.5 ± 0.5	20.0 ± 0.5	11.5 ± 0.5	45.5 ± 2.0	3.25 ± 0.50	30.0 ± 0.5	60.0 ± 2.0	73.0 ± 2.0	5.5 ± 0.2	11.8 ± 0.5	0.80 ± 0.05

## Specifications

Rated Functioning Temp. (T<sub>f</sub>) °C

Model	I <sub>r</sub> (A)	U <sub>r</sub> (V)	Rated Functioning Temp. (°C)	T <sub>h</sub> (°C)	T <sub>m</sub> (°C)	UL <sup>®</sup>	cUL <sup>®</sup>	RoHS REACH	
									UL
136	TS136-QMZ	80	AC 250	131 ± 3	91	180	●	●	●
	TS136-RJZ	100	AC 125				●	●	●
	TS136-RHZ	100	DC 100				●	●	●
125	TS125-QMZ	80	AC 250	122 ± 3	80	180	●	●	●
	TS125-RJZ	100	AC 125				●	●	●
	TS125-RHZ	100	DC 100				●	●	●
115	TS115-QMZ	80	AC 250	112 ± 3	70	180	○	○	●
	TS115-RJZ	100	AC 125				○	○	●
	TS115-RHZ	100	DC 100				○	○	●
102	TS102-QMZ	80	AC 250	99 <sup>+5</sup> <sub>-3</sub>	60	180	○	○	●
	TS102-RJZ	100	AC 125				○	○	●
	TS102-RHZ	100	DC 100				○	○	●

Note:

1. "●" Means certificated, "○" Means non-certificated.
2. RoHS & REACH Comply.

### Temp.-Time Curve

The functioning temperature time curve of Alloy Thermal-Link in different Temp. oil bath (For reference only).

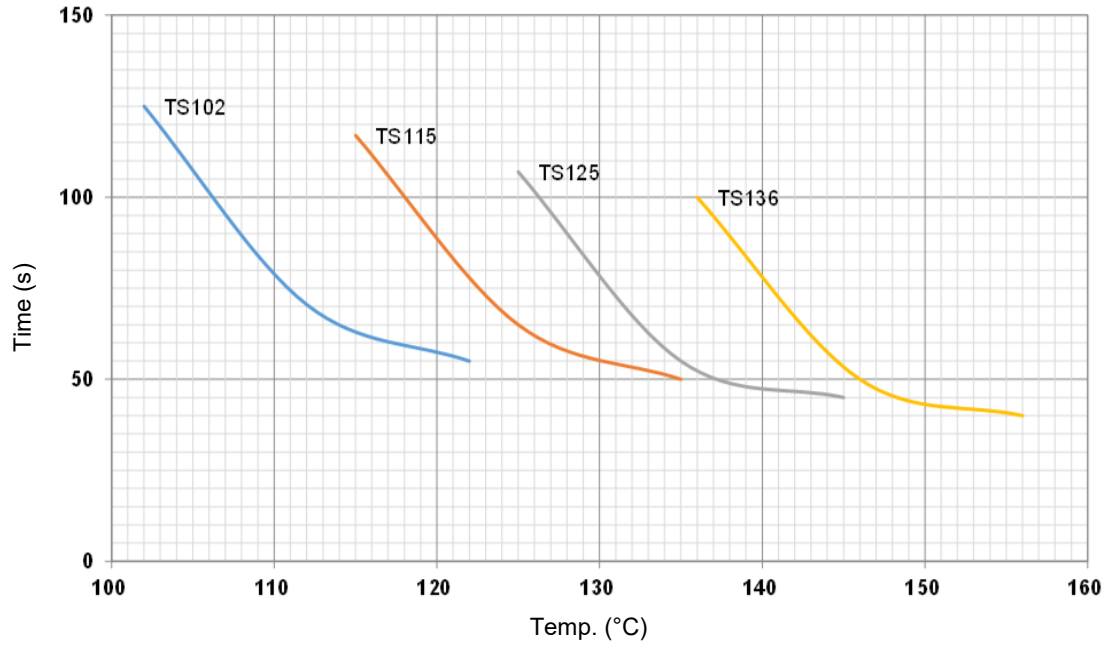

### Current-Time Curve

This is an illustrated curve, describing the opening time at Multi-times rated current in the condition of the room Temp. 25 °C (For reference only).

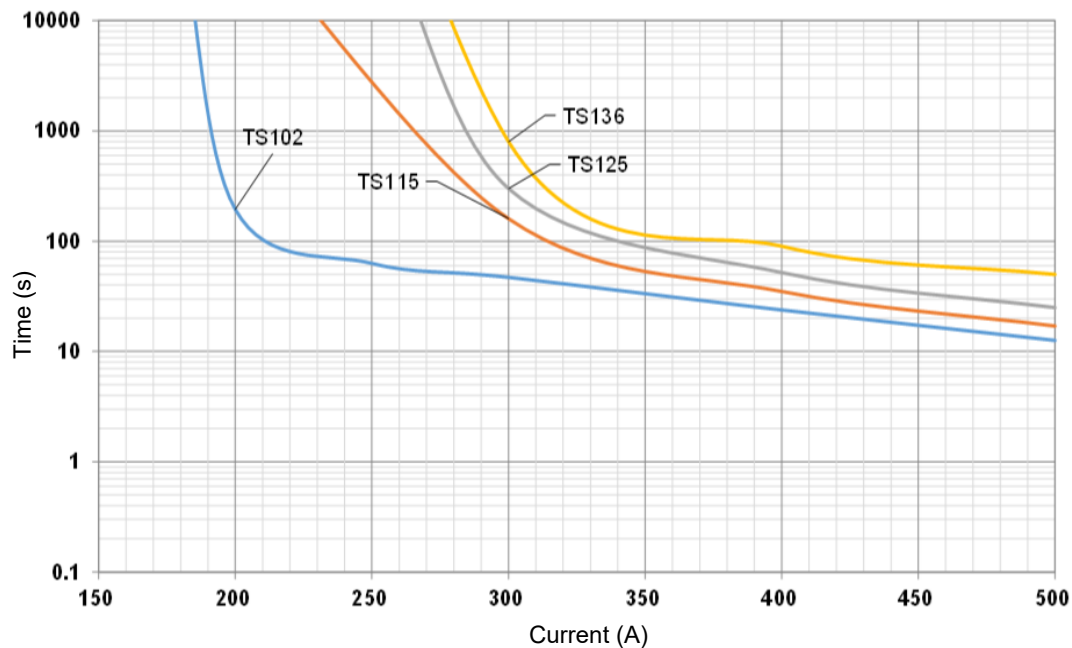

# DC-ATCO

Direct Current Thermal-Link (Alloy Type)

TS Series

## Packaging Information

Item	PE Bag	Box	Carton
Dimensions (mm)	190 x 180	165 x 245 x 67	355 x 260 x 385
Quantity (PCS)	8	80	800
Gross Weight (kg)			27.5 ± 10%

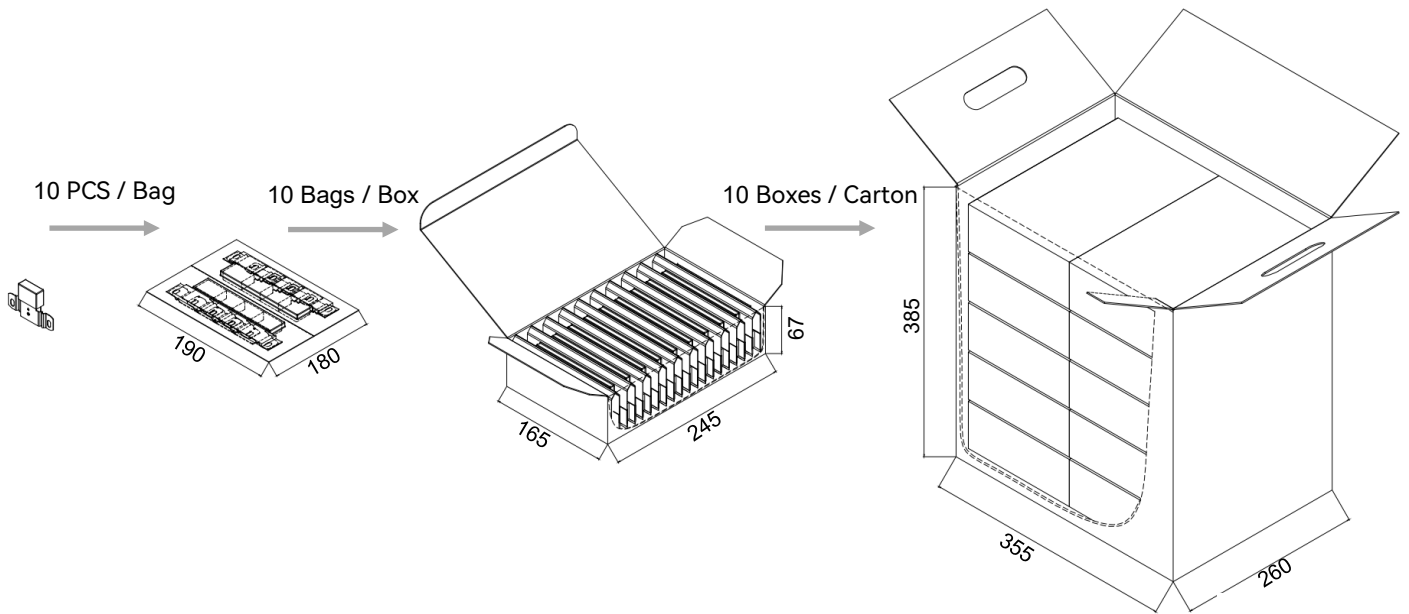

## Glossary

Item	Description
DC-ATCO	<b>DC-Alloy Thermal-Link</b> DC-Alloy type Thermal-Link, Alloy is thermal element.
$T_f$	<b>Rated Functioning Temp.</b> The temperature of the Thermal-Link which causes it to change the state of conductivity with a detection current up to 10 mA as the only load. Tolerance: $T_f$ (0 / -10) °C (GB 9816, EN 60691, K60691). Tolerance: $T_f \pm 7$ °C (J60691).
<b>Fusing Temp.</b>	<b>Fusing Temp.</b> The temperature of the Alloy Thermal-Link which causes it to change its state of conductivity is measured with silicone oil bath in which the temperature is increased at the rate of 0.5 °C to 1 °C / minute, with a detection current up to 10 mA as the only load.
$T_h$	<b>Holding Temp.</b> The Maximum temperature at which a Thermal-Link will not change its state of conductivity when conducting rated current for 168 hours.
$T_m$	<b>Maximum Temp. Limit</b> The temperature of the Thermal-Link stated by the manufacturer, up to which the mechanical and electrical properties of the Thermal-Link having changed its state of conductivity, will not be impaired for a given time.
$I_{min}$	<b>Minimum Breaking Current</b> The minimum current that Fuse requires after the Alloy of Thermal-Link opens in the circuit.
$I_r$	<b>Rated Current</b> The current used to classify a Thermal-Link, which is the maximum current that Thermal-Link allows to carry and is able to cut off the circuit safely.
$U_r$	<b>Rated Voltage</b> The voltage used to classify a Thermal-Link, which is the maximum voltage that Thermal-link allows to carry and is able to cut off the circuit safely.



## ATTENTION

### Usage

1. When atmosphere pressure is from 80 kPa to 106 kPa, the related altitude shall be from -500 m to 2000 m.
2. Operating voltage less than rated voltage of DC-ATCO, operating current less than rated current of DC-ATCO.
3. Do not touch the DC-ATCO body or lead wires directly when power is on, to avoid burn or electric shock.

### Replacement

DC-ATCO is a non-repairable product. For safety sake, it shall be replaced by an equivalent DC-ATCO from the same manufacturer, and mounted in the same way.

### Storage

Do not store the DC-ATCO at the high temp., high humidity or corrosive gas environment. The product shall be stored at  $25 \pm 5$  °C and  $\leq 70\%$  RH, avoid direct sunlight and shall use them up within 1 year after receiving the goods.

## Installation

Make Sure the Temp. of Installation Position

1. It is recommended that a dummy DC-ATCO with inbuilt thermo-couple shall be used to determine the proper temp.
2. The terminal product should be tested to ensure that potential abnormal conditions do not cause ambient temp. to exceed the  $T_m$  of the DC-ATCO.
3. Mount the DC-ATCO at the location where temp. rises evenly.

Installation position of mechanical performance requirements

1. Ensure that the lead wire is long enough, and avoid actions such as press, tensile or twist.
2. The seal or body of DC-ATCO must not be damaged, burned or over heated.









## Mechanical Connection

### Riveting



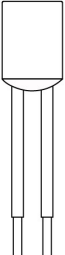

1. Choose small resistivity riveting material and be riveted.
2. A flexible lead or lead with low resistance should be used to rivet the DC-ATCO.
3. Contact resistance should be minimal, Large contact resistance will lead to higher temp., DC-ATCO Functioning in advance.

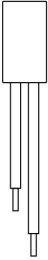

**Direct Current Thermal-Link Alloy Type (DC-ATCO) Features & Model List Overview**

Rated Functioning Temp. (T <sub>r</sub> ) °C	Model								
	TGH187-HVS <sup>^</sup>	ASL187A-LSF <sup>^</sup>	RSK187A-KSS <sup>^</sup>	RVH187-HSF <sup>^</sup>	ARL187-LRA <sup>^</sup>			RQF187-FQS <sup>^</sup>	
230	○	○	○	○	○	○	○	○	○
221	○	○	○	○	○	○	○	○	○
205	○	○	○	○	○	○	○	○	○
200	○	○	○	○	○	○	○	○	○
187	TGH187-HVS <sup>^</sup>	ASL187A-LSF <sup>^</sup>	RSK187A-KSS <sup>^</sup>	RVH187-HSF <sup>^</sup>	ARL187-LRA <sup>^</sup>	○	○	RQF187-FQS <sup>^</sup>	○
160	○	○	○	○	○	○	○	○	○
150	TGH150-HVS <sup>^</sup>	ASL150A-LSF <sup>^</sup>	RSK150A-KSS <sup>^</sup>	RVH150-HSF <sup>^</sup>	ARL150-LRA <sup>^</sup>	RPK150-HRZ <sup>^</sup>	TG150C-HQZ <sup>^</sup>	RQF150-FQS <sup>^</sup>	TG150C-JPZ <sup>^</sup>
145	○	○	○	○	○	○	○	○	○
139	○	○	○	○	○	○	○	○	○
136	TGH136-HVS <sup>^</sup>	ASL136A-LSF <sup>^</sup>	RSK136A-KSS <sup>^</sup>	RVH136-HSF <sup>^</sup>	ARL136-LRA <sup>^</sup>	RPK136-HRZ <sup>^</sup>	TG136C-HQZ <sup>^</sup>	RQF136-FQS <sup>^</sup>	TG136C-JPZ <sup>^</sup>
135	○	○	○	○	○	○	○	○	○
133	○	○	○	○	○	○	○	○	○
130	TGH130-HVS <sup>^</sup>	○	○	RVH130-HSF <sup>^</sup>	○	○	○	RQF130-FQS <sup>^</sup>	○
125	TGH125-HVS <sup>^</sup>	ASL125A-LSF <sup>^</sup>	RSK125A-KSS <sup>^</sup>	RVH125-HSF <sup>^</sup>	ARL125-LRA <sup>^</sup>	RPK125-HRZ <sup>^</sup>	TG125C-HQZ <sup>^</sup>	RQF125-FQS <sup>^</sup>	TG125C-JPZ <sup>^</sup>
123	○	○	○	○	○	○	○	○	○
120	○	○	○	○	○	○	○	○	○
115	TGH115-HVS <sup>^</sup>	ASL115A-LSF <sup>^</sup>	RSK115A-KSS <sup>^</sup>	RVH115-HSF <sup>^</sup>	ARL115-LRA <sup>^</sup>	RPK115-HRZ <sup>^</sup>	TG115C-HQZ <sup>^</sup>	RQF115-FQS <sup>^</sup>	TG115C-JPZ <sup>^</sup>
105	○	○	○	○	○	○	○	○	○
102	TGH102-HVS <sup>^</sup>	ASL102A-LSF <sup>^</sup>	RSK102A-KSS <sup>^</sup>	RVH102-HSF <sup>^</sup>	ARL102-LRA <sup>^</sup>	RPK102-HRZ <sup>^</sup>	TG102C-HQZ <sup>^</sup>	RQF102-FQS <sup>^</sup>	TG102C-JPZ <sup>^</sup>
97	○	○	○	○	○	○	○	○	○
93	○	○	○	○	○	○	○	○	○
86	○	○	○	○	ARL86-LRA <sup>^</sup>	○	TG86C-HQZ <sup>^</sup>	RQF86-FQS <sup>^</sup>	○
76	○	○	○	○	○	○	○	○	○
<b>I<sub>r</sub> (A)</b> Rated Current	15	30	25	15	30	15	15	10	20
<b>U<sub>r</sub> (VDC)<sup>^</sup></b> Rated Voltage	850		600		500		450		400
<b>U<sub>r</sub> (VAC)<sup>*</sup></b> Rated Voltage	○	○	○	○	○	○	○	○	○
<b>Product Structure</b>									
	Axial Shape		Radial Shape		Axial Shape	Radial Shape	Axial Shape	Radial Shape	Axial Shape

**Direct Current Thermal-Link Alloy Type (DC-ATCO) Features & Model List Overview**

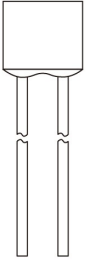
Rated Functioning Temp. ( $T_r$ ) °C	Model												
	TG150C-JSZ*				HN150^*	HP150^*	HS150^*		QD150^A	PD150^A	TD150^A	SD150^A	
230	○	○	○	○	○	○	○	○	○	○	○	○	
221	○	○	○	○	○	○	○	○	○	○	○	○	
205	○	○	○	○	○	○	○	○	○	○	○	○	
200	○	○	○	○	○	○	○	○	○	○	○	○	
187	○	○	○	○	○	○	○	○	○	○	○	○	
160	○	○	○	○	○	○	○	○	○	○	○	○	
150	TG150C-JSZ*	○	○	○	HN150^*	HP150^*	HS150^*	○	QD150^A	PD150^A	TD150^A	SD150^A	
145	○	○	○	○	○	○	○	○	○	○	○	○	
139	○	○	○	○	○	○	○	○	○	○	○	○	
136	TG136C-JSZ*	○	○	○	HN136^*	HP136^*	HS136^*	○	QD136^A	PD136^A	TD136^A	SD136^A	
135	○	○	○	○	○	○	○	○	○	○	○	○	
133	○	○	○	○	○	○	○	○	○	○	○	○	
130	○	○	○	○	○	○	○	○	QD130^A	PD130^A	TD130^A	SD130^A	
125	TG125C-JSZ*	○	○	○	HN125^*	HP125^*	HS125^*	ALP125-PLZ^A	QD125^A	PD125^A	TD125^A	SD125^A	
123	○	○	○	○	○	○	○	○	○	○	○	○	
120	○	○	○	○	○	○	○	○	○	○	○	○	
115	TG115C-JSZ*	○	○	ALP115-HLZ^A	○	○	○	○	QD115^A	PD115^A	TD115^A	SD115^A	
105	○	○	○	○	○	○	○	○	○	○	○	○	
102	TG102C-JSZ*	○	○	○	○	○	○	ALP102-PLZ^A	QD102^A	PD102^A	TD102^A	SD102^A	
97	○	○	○	○	○	○	○	○	○	○	○	○	
93	○	○	○	○	○	○	○	○	○	○	○	○	
86	○	TG86C-HSZ*	RPF86-FPF^A	○	○	○	○	○	○	○	○	○	
76	○	○	○	○	○	○	○	○	○	○	○	○	
$I_r$ (A) Rated Current	20	15	10	15	15	10	5	60	20	15 16	10	25	
$U_r$ (VDC)^A Rated Voltage	○	○	400	○	200	○	○	180	○	○	125	○	
$U_r$ (VAC)^* Rated Voltage	600	○	○	○	690	500	○	○	○	○	○	○	
Product Structure													
	Axial Shape	Radial Shape	Radial Shape	Radial Shape	Axial Shape	Radial Shape							



**Direct Current Thermal-Link Alloy Type (DC-ATCO) Features & Model List Overview**

Rated Functioning Temp. ( $T_f$ ) °C	Model													
	Q136**	Q136*	Q136*	P136**	P136*	P136*	TB136-UHZ^A	TB136-UJZ*	TS136-RHZ^A	TS136-RJZ*	S136^A	T136^A	ADN230B-NEZ	
230	○	○	○	○	○	○	○	○	○	○	○	○	○	○
221	○	○	○	○	○	○	○	○	○	○	○	○	○	○
205	○	○	○	○	○	○	○	○	○	○	○	○	○	○
200	○	○	○	○	○	○	○	○	○	○	○	○	○	○
187	○	○	○	○	○	○	○	○	○	○	○	○	○	○
160	○	○	○	○	○	○	○	○	○	○	○	○	○	○
150	○	○	○	○	○	○	○	○	○	○	S150^A	T150^A	○	○
145	○	○	○	○	○	○	○	○	○	○	○	○	○	○
139	○	○	○	○	○	○	○	○	○	○	○	○	○	○
136	Q136**	Q136*	Q136*	P136**	P136*	P136*	TB136-UHZ^A	TB136-UJZ*	TS136-RHZ^A	TS136-RJZ*	S136^A	T136^A	○	○
135	○	○	○	○	○	○	○	○	○	○	○	○	○	○
133	○	○	○	○	○	○	○	○	○	○	○	○	○	○
130	○	○	○	○	○	○	TB130-UHZ^A	TB130-UJZ*	○	○	○	○	○	○
125	Q125**	○	○	P125**	○	○	TB125-UHZ^A	TB125-UJZ*	TS125-RHZ^A	TS125-RJZ*	○	○	○	○
123	○	○	○	○	○	○	○	○	○	○	○	○	○	○
120	○	○	○	○	○	○	○	○	○	○	○	○	○	○
115	Q115**	Q115*	Q115*	P115**	P115*	P115*	TB115-UHZ^A	TB115-UJZ*	TS115-RHZ^A	TS115-RJZ*	S115^A	T115^A	○	○
105	○	○	○	○	○	○	○	○	○	○	○	○	○	○
102	Q102**	○	○	P102**	P102*	P102*	TB102-UHZ^A	TB102-UJZ*	TS102-RHZ^A	TS102-RJZ*	S102^A	T102^A	○	○
97	○	○	○	○	○	○	○	○	○	○	○	○	○	○
93	○	○	○	○	○	○	○	○	○	○	○	○	○	○
86	○	○	○	○	○	○	○	○	○	○	○	○	○	○
76	○	○	○	○	○	○	○	○	○	○	○	○	○	○
$I_r$ (A) Rated Current	25			20			200		100		10	15 16	50	
$U_r$ (VDC)^A Rated Voltage	120						100	○	100	○	100	60		
$U_r$ (VAC)* Rated Voltage	400	300	250	400	300	250	○	125	○	125	○	○		
Product Structure														
							Radial Shape						Axial Shape	

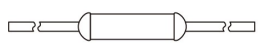
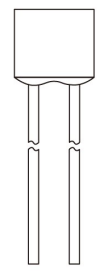
**Direct Current Thermal-Link Alloy Type (DC-ATCO) Features & Model List Overview**

Rated Functioning Temp. ( $T_f$ ) °C	Model																							
	R31^*	U31^*						C31^*					B31^*	H31^*	V31^*	V31^*			X31^*	K31^*				
230	○	○	○	○	○	○	○	○	○	○	○	○	○	○	○	○	○	○	○	○	○	○		
221	R31^*	○	U31^*	○	○	○	○	○	○	○	○	○	○	B31^*	○	H31^*	V31^*	V31^*	○	○	X31^*	K31^*	○	
205	R32^*	○	U32^*	○	○	○	○	○	○	○	○	○	○	B32^*	○	H32^*	V32^*	V32^*	○	○	X32^*	K32^*	○	
200	○	○	○	○	○	○	○	○	○	○	○	○	○	○	○	○	○	○	○	○	○	○	○	
187	○	○	○	○	○	○	○	○	○	○	○	○	○	○	○	○	○	○	○	○	X17^*	K17^*	○	
160	R16^*	○	U16^*	○	○	○	○	○	○	○	○	○	○	○	H16^*	V16^*	○	○	○	○	X16^*	K16^*	F16^*	
150	R7^*	○	U7^*	○	○	○	○	○	○	○	○	○	○	○	○	○	○	○	○	○	X7^*	K7^*	F7^*	
145	R6^*	○	U6^*	C6^*	○	○	○	○	○	○	○	○	○	○	○	○	○	○	K6^*	F6^*	X6^*	K6^*	F6^*	
139	○	CR13^*	○	○	M13^*	C13^*	○	○	○	SF13^*	V13^*	○	○	○	○	○	○	○	○	F13^*	○	○	F13^*	
136	○	○	○	○	○	○	○	○	○	○	○	○	○	○	○	○	○	○	○	K9^*	○	X9^*	K9^*	○
135	R5^*	○	U5^*	○	○	○	○	○	○	○	○	○	○	○	○	○	○	○	○	○	X5^*	K5^*	○	
133	○	○	○	○	○	○	○	○	○	○	V8^*	○	SF8^*	○	○	○	○	○	○	○	F8^*	X8^*	K8^*	F8^*
130	R4^*	○	U4^*	○	○	○	○	○	○	○	V4^*	○	SF4^*	○	○	○	○	○	○	○	F4^*	X4^*	K4^*	F4^*
125	R3^*	○	U3^*	○	○	○	○	○	○	○	○	○	○	○	○	H3^*	○	○	○	○	X3^*	K3^*	F3^*	
123	○	○	○	○	○	○	○	○	○	○	○	○	○	○	○	○	○	○	○	○	○	○	○	○
120	○	○	○	○	○	○	○	○	○	○	○	○	○	○	○	○	○	○	○	○	○	○	○	○
115	R2^*	○	U2^*	○	○	○	C2^*	○	○	○	V2^*	○	SF2^*	○	○	○	○	○	○	○	F2^*	X2^*	K2^*	F2^*
105	○	○	○	○	○	○	○	○	○	○	○	○	○	○	○	○	○	○	○	○	○	○	○	○
102	R1^*	○	U1^*	○	○	○	○	○	○	○	○	○	○	○	○	○	○	○	○	○	F1^*	X1^*	K1^*	F1^*
97	○	○	○	○	○	○	○	○	○	○	○	○	○	○	○	○	○	○	○	○	○	○	○	○
93	○	○	○	○	○	○	○	○	○	○	○	○	○	○	○	○	○	○	○	○	○	○	○	○
86	R18^*	○	U18^*	○	○	○	○	C18^*	○	○	○	○	○	○	V18^*	○	○	○	○	○	F18^*	X18^*	K18^*	F18^*
76	R0^*	○	U0^*	○	○	○	○	○	○	○	○	○	○	○	○	○	○	○	○	○	X0^*	K0^*	F0^*	
<b>Product Structure</b>	<b><math>I_f</math> (A) Rated Current</b>																							
	15      10      9      8.5      8      6      5      4      3      2.5      2      1      4      3      2      1																							
	<b><math>U_f</math> (VDC)^* Rated Voltage</b>																							
<b>Product Structure</b>	60																							
	<b><math>U_f</math> (VAC)^* Rated Voltage</b>																							
	250      ○      250      ○      250      ○      250      125      ○      250																							
<b>Product Structure</b>																								
	Axial Shape																							
																								
<b>Product Structure</b>	Radial Shape																							

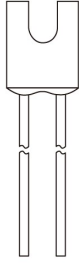
**Direct Current Thermal-Link Alloy Type (DC-ATCO) Features & Model List Overview**

Rated Functioning Temp. (T <sub>r</sub> ) °C	Model														
	230	○	○	○	○	○	○	○	○	○	○	ADN230B-NDZ <sup>Δ</sup>	ADN230B-PDZ <sup>Δ</sup>	○	ADN230B-QBZ <sup>Δ</sup>
221	XG31*	KG31*	○	○	C31*	○	B31*	○	H31*	○	○	○	ADN205B-NDZ <sup>Δ</sup>	○	
205	XG32*	KG32*	○	○	C33*	○	B32*	○	H32*	○	○	○	○	○	
200	○	○	○	○	○	○	○	○	○	○	○	○	○	○	
187	○	○	○	○	○	○	○	○	○	○	○	○	○	○	
160	XG16*	KG16*	○	○	○	B16*	○	○	○	○	○	○	○	○	
150	XG7*	KG7*	C7 <sup>Δ</sup>	C7*	○	B7 <sup>Δ</sup>	○	H7 <sup>Δ</sup>	○	V7 <sup>Δ</sup>	○	○	○	○	
145	XG6*	KG6*	C6 <sup>Δ</sup>	C6*	○	B6 <sup>Δ</sup>	○	H6 <sup>Δ</sup>	○	V6 <sup>Δ</sup>	○	○	○	○	
139	○	○	C13 <sup>Δ</sup>	C13*	○	B13 <sup>Δ</sup>	○	H13 <sup>Δ</sup>	○	V13 <sup>Δ</sup>	○	○	○	○	
136	XG9*	KG9*	C9 <sup>Δ</sup>	C9*	○	B9 <sup>Δ</sup>	○	H9 <sup>Δ</sup>	○	V9 <sup>Δ</sup>	○	○	○	○	
135	XG5*	KG5*	C5 <sup>Δ</sup>	C5*	○	B5 <sup>Δ</sup>	○	H5 <sup>Δ</sup>	○	V5 <sup>Δ</sup>	○	○	○	○	
133	XG8*	KG8*	C8 <sup>Δ</sup>	C8*	○	B8 <sup>Δ</sup>	○	H8 <sup>Δ</sup>	○	V8 <sup>Δ</sup>	○	○	○	○	
130	XG4*	KG4*	C4 <sup>Δ</sup>	C4*	○	B4 <sup>Δ</sup>	○	H4 <sup>Δ</sup>	○	V4 <sup>Δ</sup>	○	○	○	○	
125	XG3 <sup>Δ</sup> *	KG3 <sup>Δ</sup> *	C3 <sup>Δ</sup>	C3*	○	B3 <sup>Δ</sup>	○	○	○	V3 <sup>Δ</sup> *	○	○	○	○	
123	○	○	○	○	○	○	○	○	○	○	○	○	○	○	
120	○	○	○	○	○	○	○	○	○	○	○	○	○	○	
115	XG2 <sup>Δ</sup> *	KG2 <sup>Δ</sup> *	C2 <sup>Δ</sup>	C2*	○	B2 <sup>Δ</sup>	○	H2 <sup>Δ</sup>	○	V2 <sup>Δ</sup> *	○	○	○	○	
105	○	○	○	○	○	○	○	○	○	○	○	○	○	○	
102	XG1 <sup>Δ</sup> *	KG1 <sup>Δ</sup> *	○	C1 <sup>Δ</sup> *	C1*	B1 <sup>Δ</sup> *	B1*	H1 <sup>Δ</sup> *	H1*	V1 <sup>Δ</sup> *	V1*	○	○	○	
97	○	○	○	○	C21 <sup>Δ</sup> *	○	B21 <sup>Δ</sup> *	○	H21 <sup>Δ</sup> *	○	V21 <sup>Δ</sup> *	○	○	○	
93	○	○	○	○	○	○	○	○	○	○	○	○	○	○	
86	XG18 <sup>Δ</sup> *	KG18 <sup>Δ</sup> *	○	C18 <sup>Δ</sup> *	C18*	B18 <sup>Δ</sup> *	B18*	H18 <sup>Δ</sup> *	H18*	V18 <sup>Δ</sup> *	V18*	○	○	○	
76	XG0*	KG0*	○	C0*	○	B0 <sup>Δ</sup> *	B0*	H0 <sup>Δ</sup> *	H0*	V0 <sup>Δ</sup> *	V0*	○	○	○	
<b>I<sub>r</sub> (A)</b> Rated Current	3	2	7	5	3	2	1	50	55	50	80				
<b>U<sub>r</sub> (VDC)<sup>Δ</sup></b> Rated Voltage	60		50								49	48	24		
<b>U<sub>r</sub> (VAC)<sup>*</sup></b> Rated Voltage	250		○	250	125	250	125	250	125	250	125	○			
<b>Product Structure</b>	 <p>Radial Shape</p>				 <p>Axial Shape</p>				